

Article number: 03442017

Description: Fluro Rod end GE 17EC-NIRO

Measures

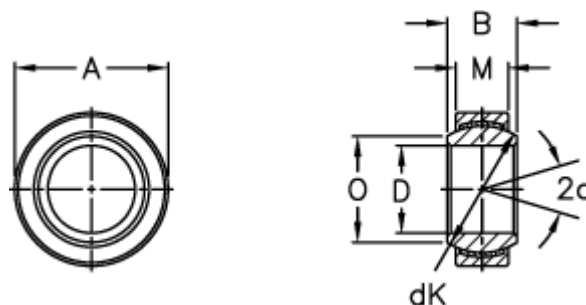

A	= 30 0 -0,009	Tilt angle = 10
B	= 14	Weight = 38
D	= 17 0 -0,008	
dK	= 25	
Dynamic load C (kN)	= 39	
M	= 10	
O	= 20.7	
Static load C0 (kN)	= 65	